

# SINGLE WINDOW AUTOMOTIVE CLEANING SOLUTIONS



**COMPLETE  
CAR CARE  
SOLUTION**



**MANMACHINE  
SPIRIT**

**MANMACHINE WORKS  
DRIVING THE CLEANING REVOLUTION**

**MANMACHINE  
WORKS**

Changing the face of cleaning...

The name MANMACHINE WORKS is synonymous with advanced cleaning technology in India. Manmachine Works is bringing the latest and most innovative cleaning solutions for a fast changing and highly demanding automotive industry requirements. It offers not only a wide range of cleaning equipment from the world leaders but also complete cleaning solutions, starting from designing a car wash to promoting professional skills by introducing the first ever "CAR WASH COLLEGE" in India.

**PARTNERING WITH WORLD-CLASS TECHNOLOGY**



Since 1958, Annovi Reverberi is leading the international market with distinguished solutions. Counted among the leading manufacturers of pressure washers



Founded by a group of young entrepreneurs in 2001, ELSEA's expanded range of products are internationally certified by ISO 9001:2008



Founded in 1950, the company commands presence in more than 75 countries with more than 900 employees and an impressive legacy of more than 70 years of manufacturing automatic car washing machines.



**STEAMJET**  
"STEAMJET prepares for a better future and a better environment."  
STEAMJET is NOT an ordinary steam generator. It is the product of 10 years of research, development and delicately patented design for superior steam car wash.



**MAFRA**  
Founded in 1965, MA-FRA has always been on the customers side, MA-FRA in association with Manmachine are proud to launch a complete car wash range which is European Quality but MADE IN INDIA.



**BIEMMEDUE**  
Biemmedue is headquartered in Cherasco, Piedmont (northwest Italy), at the Gates of the Langhe and Roero regions. In 25000m<sup>2</sup> of factory space where product are manufactured using innovative laser cutting systems



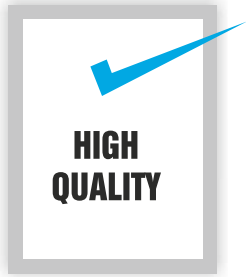

# DELIVERING SMARTER AND RESOURCE EFFICIENT HIGH PRESSURE CAR WASHER

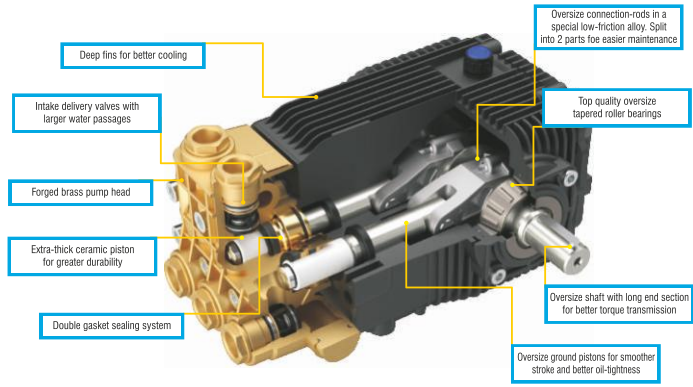

## HIGH PRESSURE CAR WASHER RANGE BY ANNOVI REVERBERI, ITALY



### TECHNICAL SPECIFICATIONS

Car Washer Range	No. of Cars	Output		Pressure		Power		RPM	3 ~ 50 Hz	Weight
	Per Day	l/min	gpm	bar	psi	hp	kw	N° giri/1'	volt	kg
AR - 613 (1φ)	4-5	8.5	2.20	150	2200	3	2.4	1450	220-230	15
BC - 780 (1φ)	8-10	12	3.20	130	1900	4	3	1450	220-230	32
HRC 11.11 ET (1φ)	8-10	12	3.20	130	1900	4	3	1450	220-230	29
HRC 12.13 ET (3φ)	15-20	12	3.20	130	1900	4	3	1450	230/400	29
HRK 11.14 ET (3φ)	25-30	11	2.90	140	2000	5.5	4	1450	230/400	33
HRG 21.15 ET (3φ)	Non Stop (LCV/HCV)	21	5.50	150	2200	7.5	5.5	1450	230/400	60
BC 1007 (3φ)	Movable (Comm. Vehicle)	15	3.90	200	2900	10	7.4	1450	230/400	67.7

### ABOVE MACHINE COMES WITH BELOW SIX STANDARD ACCESSORIES

- ❑ Hose Pipe 10m
- ❑ Gun with quick connect system
- ❑ Lance 500mm
- ❑ 100 Micron Filter
- ❑ 10 Micron Filter (Only By MMW)
- ❑ Nozzle 25°

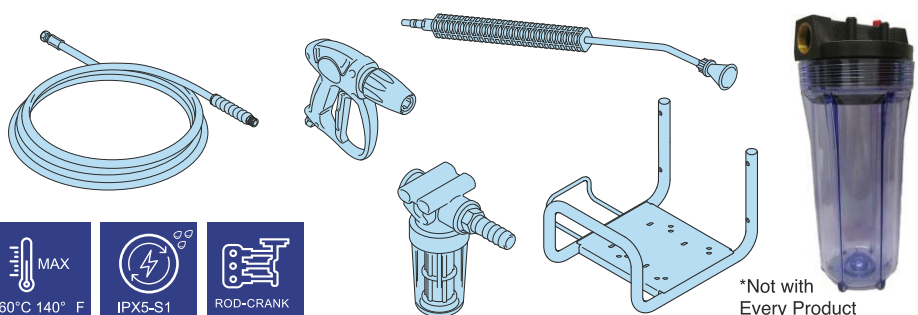

\*Not with Every Product

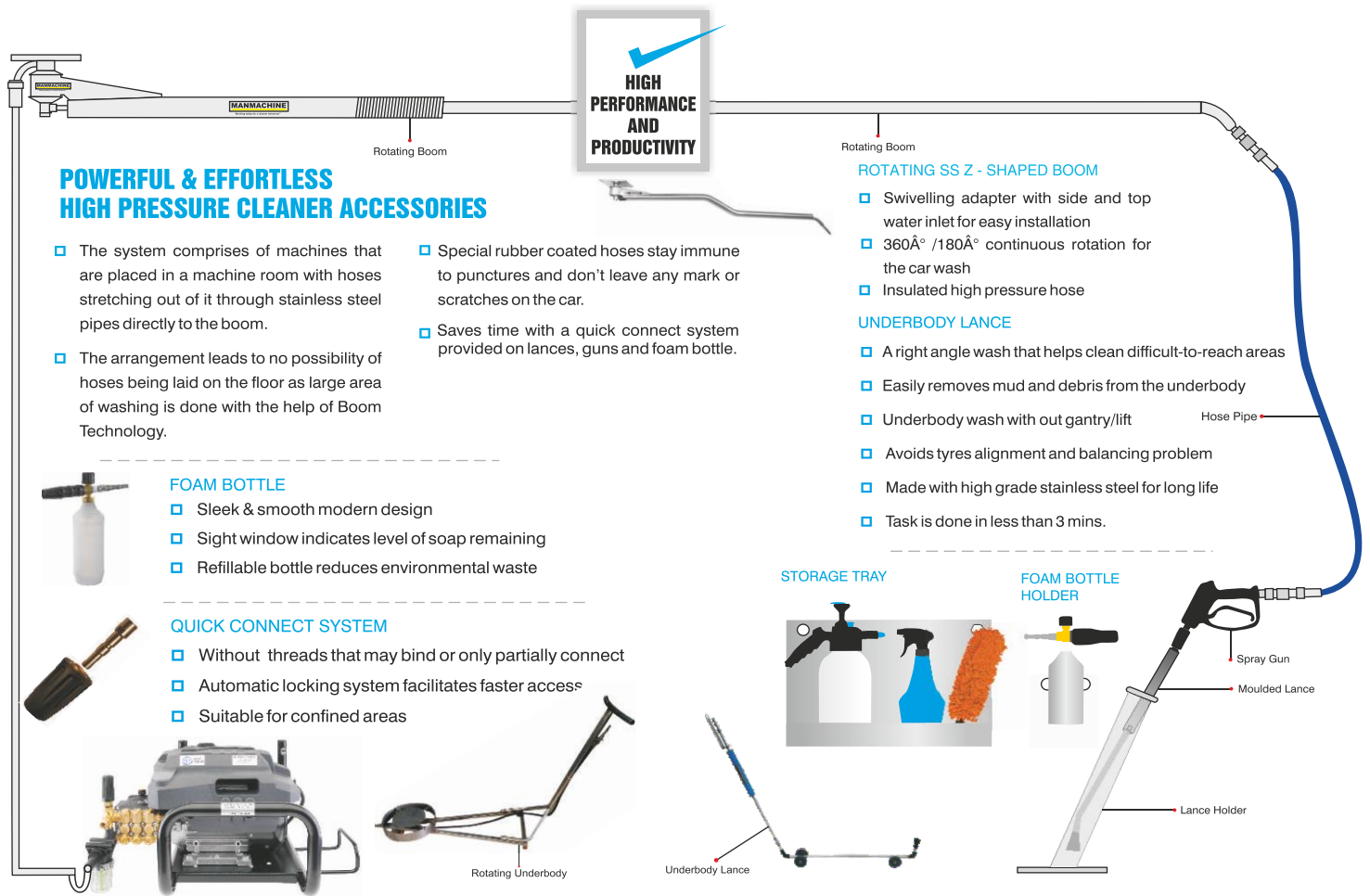

## TECHNICAL SPECIFICATIONS

PARAMETER	9 NOZZLE U.B	3 NOZZLE U.B
High Pressure Triple Ceramic Plunger Pump	40 LPM.	21 LPM.
Pressure	100 bar	150 bar
Power Requirement	10 HP/7.5 kw	7.5 HP/5.5 kw
Power Consumption	0.3 Unit	0.2 Unit
Water Consumption Per vehicle for Under	35-40 ltrs	16-21 ltrs
Total time for undercarriage	1 min	1 min
Maximum washing Length	5.8 mtr.	5.8 mtr.
Maximum Washing width	2.2 mtr.	2.2 mtr.

## ROBOTIC UNDERBODY WASH



## SUSETTE 180/13

PROFESSIONAL HOT & COLD WATER HIGH PRESSURE CLEANERS

Susette 180/13 three phase heavy duty 4 in 1 machine performs all four below functions. In terms of safety this machine has various safety features like ACDS(advance control delay system), Automatic shutdown if idle for 20 min, Warning LED, "Machine Ready" & "Malfunctioning", Double thermostat control, Lime scale prevention system etc.

1. High pressure wash.
2. Hot water wash.
3. Steamwash.
4. Foaming with inbuilt foam tank of 3L

## TECHNICAL SPECIFICATIONS

Model	Susette 180/13	
Max. Pressure	[bar]	30-180
Max. Flow rate	[lt/h]	400-780
Pump		AR-RK
Stop System		ACDS
Pump Speed	[rpm]	1,450
Max. absorbed Power	[kw]	4.7 kw
Supply Voltage	[V-ph-Hz]	420-3-50
Max. Temperature	[°C]	140
Fuel Tank	[it]	35
Cleaning agent Tank	[it]	3
Weight		123 kg
Packaging Dimension		1015x660x110



## STANDARD ACCESSORIES



# VACUUM CLEANERS

The multi-purpose range of vacuum cleaners are ideal for interiors of the car, workshops, garages and outside areas. An intelligent machine design that's energy efficient and optimized for maximum performance in all applications. The state-of-the-art accessories enhance its suction power and versatility.

## ARES 37/1

Wet & Dry Vacuum Cleaner with double stage motor reaches upto 1400w of maximum power.



### TECHNICAL SPECIFICATIONS

Number Motors	1
P max (W)	1400
Waterlift (mm H <sub>2</sub> O)	2400
Air flow (m <sup>3</sup> /h)	215
Total tank capacity (lt)	37



## EXCEL M – 77/2

Ideal for professional cleaning, with two double stage motors reaching upto 2600w of maximum power.



### TECHNICAL SPECIFICATIONS

Number Motors	2
P max (W)	2600
Waterlift (mm H <sub>2</sub> O)	2400
Air flow (m <sup>3</sup> /h)	430
Total tank capacity (lt)	77/76



### USP's

- Strong & Virgin polypropylene material for longer life.
- 4m Flexible Hose, longest in the category, as standard, making car vacuuming easier & faster
- Special Car Tool as standard for operator's comfort & faster vacuuming
- Polyester Ring Filter as standard for ease of operation
- Large Caster wheel & trolley for free movement & greater stability

### STANDARD ACCESSORIES



# SPRAY EXTRACTION / CAR INTERIOR CLEANER

A comprehensive new age range of spray extraction machines that are compact, powerful and manageable. Equipped with a strong suction power and inbuilt detergent tank, they are miraculous performers in wet cleaning, dry cleaning, armchair wash and floor wash.

## ESTRO-125

An extractor with double stage motor that's ideal for applications such a cleaning of car interiors & upholstery. The model is designed with an innovative 8 ltrs. detergent tank to be assimilated to the trolley and completely residual liquids tank.

### TECHNICAL SPECIFICATIONS

Number Motors	1
P max (W)	1400
Air flow (m <sup>3</sup> /h)	215
Total tank capacity (lt)	37
Cooling	by pass
Detergent tank (lt)	8
Pump (W)	48

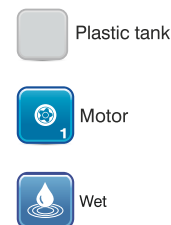

## ESTRO-250

An extractor with double stage motor that's ideal for applications such as cleaning of car interiors & upholstery. The model is designed with an innovative 20 ltrs. detergent tank to be assimilated to the trolley and completely residual liquids tank.

### TECHNICAL SPECIFICATIONS

Number motors	2
P max (W)	2600
Air flow (m <sup>3</sup> /h)	430
Total tank capacity (lt)	77/76
Detergent tank (lt)	16
Pump (W)	48

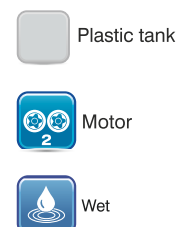



# THREE PHASE INDUSTRIAL VACUUM CLEANER

IDEAL FOR INTENSIVE AND CONTINUOUS USES.  
EQUIPPED WITH A 3.0KW THREE-PHASE TURBINE.



Technical Specification	
Model	Slim BI55105
No Of Engines	1
Stages	Double
Engine Type [V-Hz]	Turbine[400V-50Hz]
Power Max[kW]	5.5
Water Lift[mmH2O]	2800
Air Flow[m3/h]	640
Noise Ration[dB]	74
Suction Tank Capacity[L]	90
Degree Of Protection	Ip65
Weight[kg]	98
Dimensions[mm]	893X424X1050



## FEATURES & BENEFITS

- ❑ Hose made up of Virgin Polypropylene which is highly unbreakable.
- ❑ Comes complete with two hoses of 5m each with Y-shape connector.
- ❑ Can be run for complete day operation with heavy duty turbine.
- ❑ Can be easily move from one place to another thanks to lockable castors.
- ❑ Supplied with special car tool for ease & faster Vacuuming.

# STEAM POSEIDON

Single Phase dry cleaning & Steam machine specially designed for deep interior dry cleaning, disinfection, Sanitizing etc. Heavy duty machine equipped with double motor vacuuming function for higher suction power and dedicated pump for spraying detergent from the inbuilt detergent tank of 5L.

## TECHNICAL SPECIFICATIONS

	<b>Sw1220</b>
Power	230V - 50Hz
Boiler capacity	2,2 lt
Boiler power	2000 W
Working pressure	9 BAR
Steam temperature in the boiler	165°
Pmax vacuum	2050 W
Stainless tank capacity	60 lt
Water tank capacity	5,0 lt
Weight (kg)	36 kg



# STEAM JET CAR CLEANING & WAX SYSTEM



- ❑ Steamjet(FX1D) using only 7-8L of water to wash complete car
- ❑ Patented machine for steam wash & wax in single action
- ❑ CPU controlled with only 200- watt power and minimum fuel consumption
- ❑ Commercial grade equipment that runs all day non stop
- ❑ Non- boiler technology which is completely safe with preheating time less than 1 minute
- ❑ Steam temperature is 80 - 90 C(176 - 203 F)
- ❑ Steam pressure is 6 - 8 Bars, safe for engine wash & painted body parts.
- ❑ Complete unit weight is only 67 Kg with movable & lockable castors.
- ❑ Inbuilt Water tank of 21 L
- ❑ Inbuilt Wax tank of 6.5 L
- ❑ Inbuilt Fuel(Diesel only) tank of 6.5 L

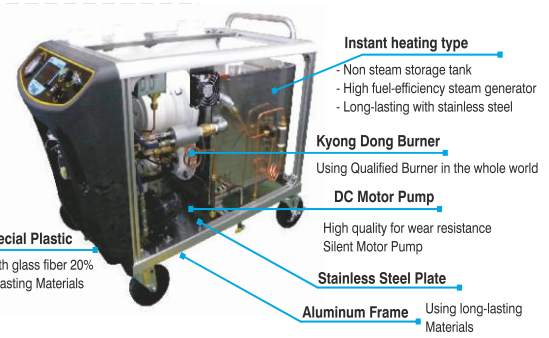

# AUTOMATIC CAR WASH SYSTEMS

'M START' and M1 is a rollover designed for wash facilities with a capacity of 1000 to 1500 vehicles a month and the perfect machine for those wishing to start off in the vehicle business in the most profitable way.



- ❑ European Quality with the capacity to do a full Car wash in 4 minutes
- ❑ LCD screen control panel which can store up To 30 program
- ❑ Brushes and dryer are driven by drive motors leading to better Cleaning and drying effects
- ❑ Maintenance free machine
- ❑ LCD screen control panel which can store up To 30 program

**Fully Automatic Car Washers  
are also available on lease only to OEM  
Customers Starting at ₹100/-per car**

# MAFRA & MANMACHINE CAR WASH CHEMICALS

- ❑ Car Wash Shampoo 
- ❑ Colour Foam 
- ❑ Glass Cleaner 
- ❑ Super Wax 
- ❑ Super Foam 
- ❑ Tyre Glaze 
- ❑ Degreaser 
- ❑ Upholstery Shampoo Cleaner 
- ❑ Dashboard Shiner 
- ❑ Plastic & Leather Cleaner 



# ZENTOO DUAL ACTION POLISHERS

The Zentool Dual Action Polishers represents one of the latest advancements in machine polishing technology. Has an orbits (throw) of 21mm, Compared to rotary polishers this machine achieves a far superior finish with no holograms. Rotary polishers can cut easily but leaves too many pain defects.



# ROTARY POLISHING MACHINE

GLADIUS R56 ROTARY: ergonomically designed to reduce fatigue in long operations. Light, only 2.2kg. It is equipped with a 5" - 6" soft-edged pads. Voltage Frequency: 220-240V 50/60Hz (CE/CN version), 100-127V- 50/60Hz (UL/JP version). Power Consumption: Rated 800w, (Maximum 1200w). Free Speed: 700-2500/min. Weight: 4-7/81lbs (2.2kg). Gear system: Two deduction levels.



## BEST-IN -CLASS SERVICE WITH EXPERT SUPPORT & TRAINING

Highly focused towards 100% customer satisfaction, our nationwide network of service centers provide support throughout the complete product lifecycle ensuring high performance and reliability.

Car Wash College is an initiative to provide professional training to the operators and keep them abreast on latest techniques through programs conducted regularly.

Knowledge of chemicals, new treatments and their usage.

To achieve minimum costs per car wash through optimum usage of cleaning agents and other specialized treatments

Through a collaborative learning environment, the operators are trained for proficiently handling all aspects of machinery and generate the combined force of man and machine.



# CHANGE YOUR MIND EXPERIENCE MANMACHINE

### MANMACHINE GROUP

Corporate Office : E - 98, Sector 6, Noida - 201 301

Ph : 0120 - 4256161 / 4256262

E-mail : [info@manmachineworks.com](mailto:info@manmachineworks.com) | [www.manmachineworks.com](http://www.manmachineworks.com)

DEALER: